



SVGA 270 LCD Projector



User Guide

Thank you for purchasing this HITACHI liquid crystal projector.



Please read the accompanying manual "SAFETY INSTRUCTIONS" and this "USER'S MANUAL" thoroughly to ensure correct usage through understanding. After reading, store this instruction manual in a safe place for future reference.

NOTE:

- * The information in this manual is subject to change without notice.
- * The manufacturer assumes no responsibility for any errors that may appear in this manual
- * The reproduction, transmission or use of this documents or contents is not permitted without express written authority.

TRADEMARK ACKNOWLEDGMENT:

- * PS/2, VGA and XGA are registered trademark of International Business Machines Corporation.
- * Apple, Macintosh, Mac and ADB are registered trademarks of Apple Computer, Inc.
- * VESA and SVGA are trademarks of the Video Electronics Standard Association.
- * Windows is registered trademarks of Microsoft Corporation.
- * Carefully observe the trademarks and registered trademarks of all companies, even when not mentioned.

CONTENTS

FEATURES

BEFORE USE

- Contents of Package
- Part Names
- Loading the Battery

INSTALLATION

- Installation of the projector and Screen
- Angle Adjustment
- Cabling
- Power Connection
- Example of System Setup
- Plug & Play

OPERATIONS

- Power On/Off
- Basic Operation
- Menu Functions

MAINTENANCE

- Cleaning
- Lamp

TROUBLESHOOTING

- OSD Message
- Indicators Message
- Symptom
- Warranty and After-service

SPECIFICATIONS

- Tables:
- Table 1-1. Installation Reference
- Table 1-2. Basic Operations
- Table 1-3. Menu Functions
- Table 1-4. OSD Message
- Table 1-5. Indicator Message
- Table 1-6. Symptom
- Table 1-7. Specifications
- Table 1-8. Example of Compatible Signal

FEATURES

This liquid crystal projector is used to project various computer signals as well as NTSC / PAL / SECAM video signals onto a screen. Little space is required for installation and large images can easily be realized.

- **Outstanding brightness**

The UHB lamp and high-efficiency optical system assure a high level of brightness.

- **Partial magnification function**

Interesting parts of images can be magnified for closer viewing.

- **Distortion correction function**

Distortion-free images are quickly available.

BEFORE USE

Contents of package

Make sure all of the following items are included in the package. If anything is missing, please contact your dealer.

NOTE: Keep the original packing material for future reshipment.

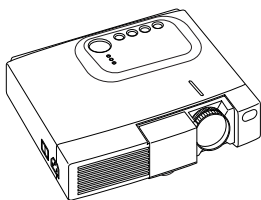

Projector



**User's Manual
(this manual)**



Safety Instructions



**Power Cord
US Type**



**Power Cord
UK Type**



**Power Cord
Europe Type**

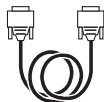

RGB Cable

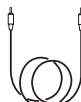

Video Cable

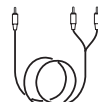

**Audio Cable
(Stereo Mini)**



Mac Adapter

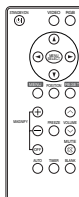

**Remote Controller
containing Battery**

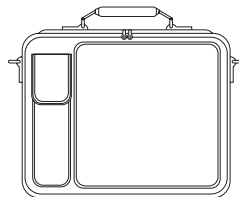

Carrying Bag

Part Names

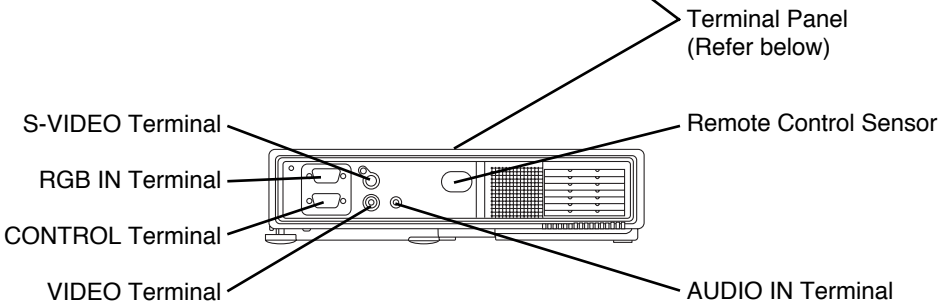
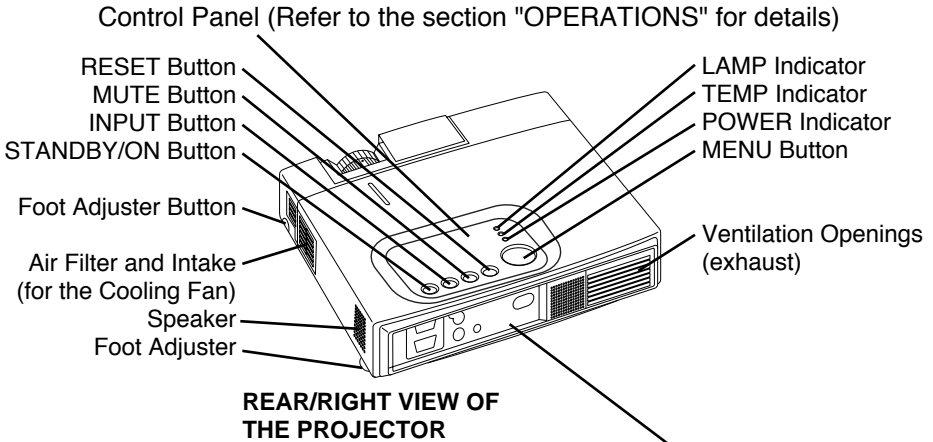
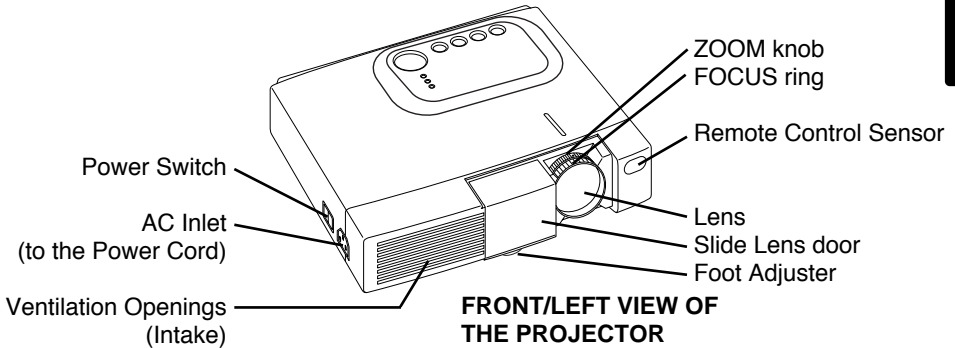

Part Names (continued)

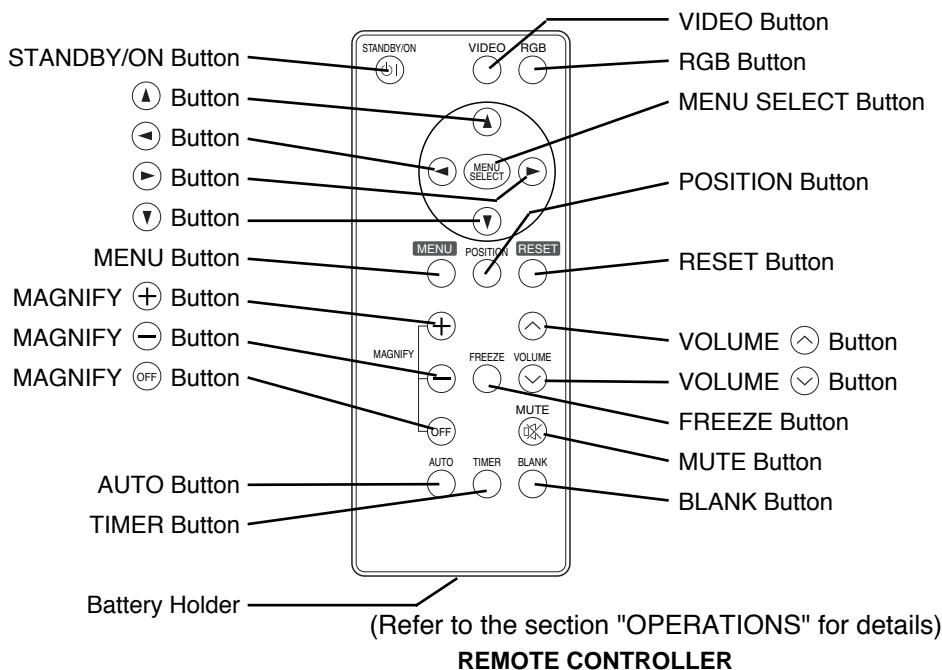

Loading the Battery

CAUTION



Danger of explosion if battery is incorrectly replaced. Be careful in handling the battery according to instructions of the accompanying manual "SAFETY INSTRUCTIONS" and this manual. Replace only with the same or equivalent type recommended by the manufacturer. Use the 3V micro lithium battery Type no. CR2025 only. When you dispose the battery, you must obey the law in the relative area or country. Keep the battery away from children and pets.

First Loading:

In original packing, the battery is installed in the battery holder of the remote controller with protection film. Pull out the protection film to load the battery.

Replacing:

1. See the reverse side of the remote controller.
2. Pinch the groove and pull out battery holder as the drawing right.
3. Remove the worn battery.
4. Install the new battery with "+" side facing.
5. Push in and click the battery holder.

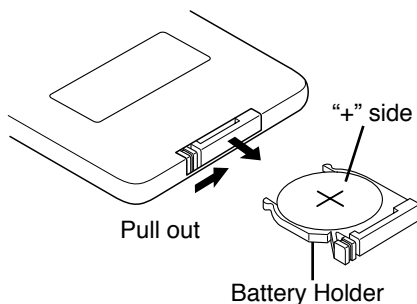

INSTALLATION

Installation of the Projector and Screen



Install the projector in a suitable environment according to instructions of the accompanying manual "SAFETY INSTRUCTIONS" and this manual.

Refer to the drawing and table below for determining of the screen size and projection distance.

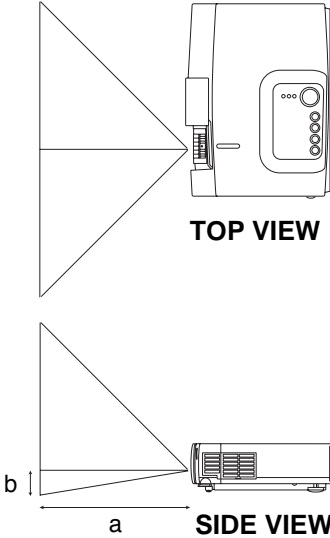

- a: Distance from the LCD projector to the screen.
The projection distance shown in the table below are for full size (800 x 600 dots).
- b: Distance from the lens center to the bottom of the screen (a, b: +/-10%)

Table 1-1. Installation Reference

Screen size (inches)	a (inches)		b (inches)
	Min.	Max.	
40	37	46	3
60	57	69	5
80	77	93	7
100	96	116	9
120	116	139	10
150	145	174	13
200	194	233	17

Installation of liquid crystal projector

Please basically use liquid crystal projector at the horizontal position.



If you use liquid crystal projector by the lens up position, the lens down position and the side up position, this may cause the heat inside to build up and become the cause of damage. Be especially careful not to install it with ventilation holes blocked.

Angle Adjustment

Use the foot adjuster on the bottom of the projector to adjust the projection angle. It is variable within 0° to 10° approximately.

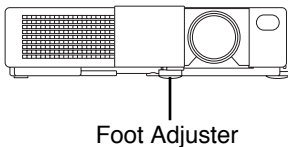

Foot Adjuster

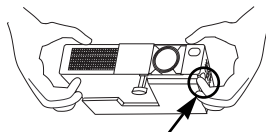

Press the foot adjuster button

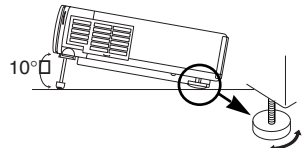

Horizontal inclination may be adjusted using the adjuster at the rear.

1. Lift up the front side of the projector.
2. Pressing the foot adjuster button, adjust the projection angle.
3. Release the button to lock at the angle to be fixed.



Do not release the foot adjuster button unless the projector is being held; otherwise, the projector could overturn or the fingers could get caught and cause personal injury.

INSTALLATION (continued)

Cabling



Before connecting, read the instruction manuals of the devices to be connected, and make sure that the projector is compatible with the device, and turn off to all devices to be connected.

RGB Signal Input:

Connect the RGB IN terminal of the projector to the display signal output of the computer by the enclosed RGB cable. Secure the screws on the connector and tighten.

For some modes, the enclosed Mac adapter is necessary. Refer to the "Table 1-8. Example of Compatible Computer Signal" of the section "SPECIFICATION".

NOTE: Some computers may have multiple display screen modes. Use of some of these modes will not be possible with this projector.

Video Signal Input:

Connect the VIDEO terminal of the projector to the video signal output of the video tape recorder by the enclosed video cable except for S-Video signal.

For S-Video signal, use the S-VIDEO terminal of the projector and the optional cable for S-Video.

Audio Signal Input:

Connect the AUDIO IN terminal of the projector to the audio signal output by the enclosed audio cable.

RS232C:

Connect the CONTROL terminal of the projector to the computer.

Power Connection:

WARNING



Be careful in handling the power cord according to instructions of the accompanying manual "SAFETY INSTRUCTIONS" and this manual. Connect the power cord firmly. Avoid using a loose, unsound outlet or contact failure.

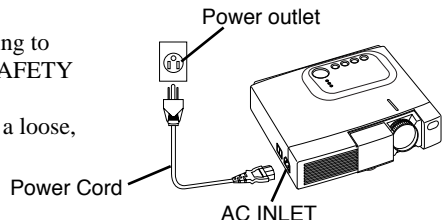

Use the correct one of the enclosed power cords depending on the power outlet to be used. Connect the AC inlet of the projector to the power outlet firmly by the power cord.

Example of system setup

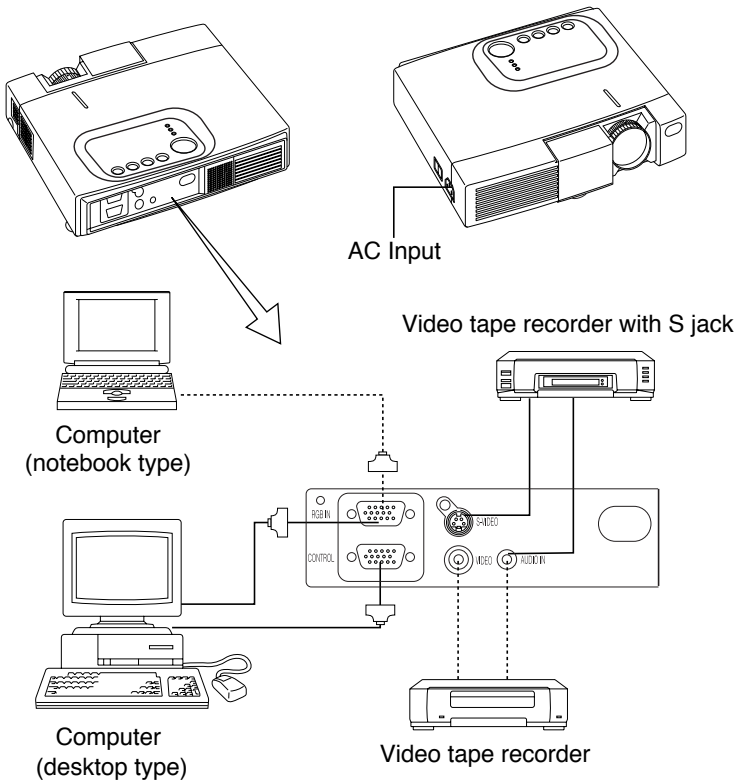

Plug & Play

This projector is VESA DDC 1/2B compatible. Plug & play is possible by connecting to a computer that is VESA DDC (Display Data Channel) compatible.

(Plug & play is a system configured with peripheral equipment including a computer and display, and an operating system.)

NOTE: Use the RGB cable included with this projector when using plug & play. With other cables, pins (12) - (15) are sometimes not connected (effective only for RGB).

OPERATIONS



Read the "SAFETY INSTRUCTIONS" of this calligraphy and the separate volume well surely and use it for the safety before the use after attention.

Power On/Off

Power On

1. Confirm that power cord is connected properly.
2. Push "I" of the power switch. Standby mode is set up and power source indicator burns in the orange.
3. Push a control panel or "STANDBY/ON" of the remote controller. A warm-up is started and power source indicator goes on and off in green.
4. When power source on is completed, power source indicator finishes blinking, and burns in green. Open a Slide lens door.
5. Adjust picture size using the projection lens ZOOM knob.
6. Adjust focus using the projection lens FOCUS ring.



Make the power source of the computer ON before projector when using a RS-232 communications function.

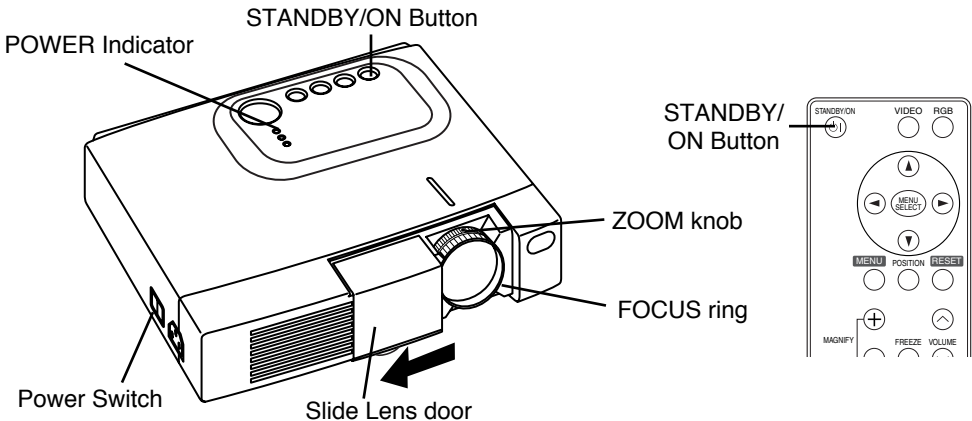

Power Off

1. Push a control panel or "STANDBY/ ON" of the remote controller for about one second. The ramp of projector disappears and cooling of the ramp is started. Power source indicator goes on and off in the orange during ramp cooling. It is ineffective even if power source indicator pushes "STANDBY/ ON" button during the blinking.
2. When ramp cooling is completed, STANDBY mode is set up and power source indicator stops blinking, and burns in the orange. Confirm this, and push the "O" side of the power switch. Don't make power switch OFF when power source indicator burns in the orange except for the emergency. The time when power source indicator is green and power source OFF during the blinking shorten the life of projector lamp.
3. Power source indicator disappears when power source OFF is completed. Close without forgetting a lens door.

Basic Operation

Basic manipulation to show in the table 1-2 can be done easily by the control panel of projector and the attached remote controller. (The item of ⊕ can manipulate with the control panel.)





Use the remote control in front of the remote control photoreceptor at a distance of about 3 m or less and an angle of 30 degrees to the left or right of the center. Be careful of the strong light and the obstacle because it sometimes obstructs remote controller manipulation.

Table 1-2. Basic Operation

Item	Description
INPUT SELECT	<p>Sequential switching of the input signal : Push INPUT ⊖ button. ⊕ RGB → VIDEO → S-VIDEO (→ RGB)</p> <p>The selection of input of RGB : Push RGB button. VIDEO/S-VIDEO → RGB</p> <p>The selection of input of VIDEO/S-VIDEO : Push VIDEO button. RGB → VIDEO/S-VIDEO S-VIDEO ↔ VIDEO</p> <p>*The signal name chosen at the time of a change in an input signal is displayed for about three seconds.</p>
POSITION	<p>A setting/release of the centering control mode : Push POSITION button. Icon [⊞] is displayed by the centering control mode.</p> <p>The accommodation of the image location : Push ⊖, ⊗, ⊕, ⊙ button by the centering control mode.</p> <p>* It is effective by the VIDEO/S-VIDEO input only at the time of the expansion mode.</p> <p>* Icon [⊞] disappears, and centering control mode is canceled automatically when it passes for about 10 seconds under the condition that manipulation isn't done.</p>
RESET ⊕	<p>The format of the menu item : Choose an appropriate item and push RESET ⊖ button.</p> <p>The format of the centering control : Push RESET ⊖ button by the centering control mode.</p>
MAGNIFY	<p>The setting of the magnify mode : Push MAGNIFY ⊕ button.</p> <p>The movement of the magnify region : Do "centering control" by the magnify mode.</p> <p>The accommodation of the magnify multiplying factor : Push MAGNIFY ⊕/⊖ by the magnify mode.</p> <p>A release of the magnify mode : Push MAGNIFY ⊗ button.</p> <p>* Expansion is canceled due to the execution/setting of "AUTO" "ASPECT" "VIDEO" or the change in the input signal.</p>
FREEZE	<p>A setting/release of the FREEZ mode : Push FREEZE button. It is displayed, and an image rests by the rest mode icon [III].</p> <p>* Rest is canceled due to the execution/setting of "centering control" "sound volume" "noise reduction" "AUTO" "BLANK ON/OFF" or "MENU ON/OFF", the change in the input signal.</p> <p>* Be careful not to forget a release the static image when it rests.</p>

OPERATIONS (continued)

Table 1.2 Basic Operation (continued)

Item	Description
VOLUME	Volume adjustment : Reduce VOLUME (⏮) ↔ Increase VOLUME (⏭)
MUTE ⊕	Set/Clear Mute mode: Press the MUTE! (⊗) button. No sound is heard in the MUTE mode.
AUTO	<p>Automatic adjustment at RGB input: Press the AUTO button. Horizontal position(H.POSIT), vertical position,(V.POSIT) clock phase (H.PHASE), and horizontal size(H.SIZE) are automatically adjusted. Use with the window at maximum size in the application display.</p> <p>Automatic adjustment at VIDEO/S-VIDEO input: Press the AUTO! button. A signal type appropriate for the input signal is selected automatically. Valid only when AUTO is set for VIDEO on the menu. * This operation requires approximately ten seconds. It may not function correctly with some input signals.</p>
TIMER ON/OFF	<p>Timer start/stop: Press the TIMER button. Count-down and display by the minute from the initial value (1~99) set in TIMER on the Options menu to 0. * The timer does not display in the BLANK MODE or STATIC MODE.</p>
BLANK ON/OFF	<p>Set/Clear Blank mode: Press the BLANK button. No image is displayed in the Blank mode. The screen color is as set in BLANK on the Image menu.</p>
MENU ON/OFF ⊕	<p>Menu display start/stop: Press the MENU button. * The menu display is terminated automatically after approximately ten seconds of inactivity.</p>
MENU SELECT	<p>Select menu type: Press the MENU SELECT button. Allows the user to select the normal menu or the single menu. Only the selected item is displayed on the single menu, and other items are displayed with the (▲) and (▼) buttons as with the normal menu. * Valid only when the menu is used. Push MENU SELECT button after choosing an item such as "BRIGHTNESS".</p> <div style="display: flex; align-items: center; justify-content: center;"> <div style="text-align: center;"> <p>Normal menu</p>  </div> <div style="margin: 0 20px;"> <p>(MENU SELECT)</p>  </div> <div style="text-align: center;"> <p>Single menu</p>  </div> </div>

OPERATIONS (continued)

Setup Menu

The following adjustments and settings are possible when SETUP is selected at the top of the menu. Part of the Setup menu differs between RGB input and VIDEO/S-VIDEO input. Select an item with the \blacktriangle and \blacktriangledown buttons, and start operation. Use the Single menu to reduce menu size (see Table 1.2 MENU SELECT).

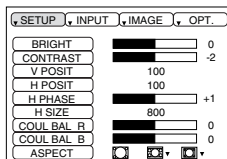

RGB

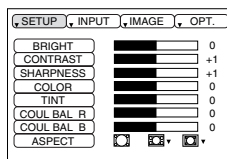





Video

Table 1.3 Setup Menu

Item	Description	RGB	VIDEO S-VIDEO
BRIGHTNESS	Adjustment: Dark \blacktriangleleft \leftrightarrow Light \blacktriangleright	✓	✓
CONTRAST	Adjustment: Weak \blacktriangleleft \leftrightarrow Strong \blacktriangleright	✓	✓
V. POSIT	Adjustment: Down \blacktriangleleft \leftrightarrow Up \blacktriangleright	✓	-
H. POSIT	Adjustment: Left \blacktriangleleft \leftrightarrow Right \blacktriangleright	✓	-
H. PHASE	Adjustment: Left \blacktriangleleft \leftrightarrow Right \blacktriangleright * Adjust to eliminate flicker.	✓	-
H. SIZE	Adjustment: Small \blacktriangleleft \leftrightarrow Large \blacktriangleright * The image may not displayed correctly if the horizontal size is excessive. In such cases, press the RESET button, and initialise the horizontal size.	✓	-
SHARPNESS	Adjustment: Soft \blacktriangleleft \leftrightarrow Clear \blacktriangleright	-	✓
TINT	Adjustment: Light \blacktriangleleft \leftrightarrow Dark \blacktriangleright	-	✓
COLOR	Adjustment: Red \blacktriangleleft \leftrightarrow Green \blacktriangleright * Only when it is received, it is effective the signal of the NTSC or NTSC4.43.	-	✓
COLOR BAL R	Adjustment: Light \blacktriangleleft \leftrightarrow Dark \blacktriangleright	✓	✓
COLOR BAL B	Adjustment: Light \blacktriangleleft \leftrightarrow Dark \blacktriangleright	✓	✓
ASPECT	Select image aspect ratio: 4:3[] \blacktriangleleft \leftrightarrow \blacktriangleright 16:9[] \blacktriangleleft \leftrightarrow \blacktriangleright 4:3 small[] Select image aspect ratio: Press \blacktriangledown button while 16:9[]/4:3 small[] is selected. Center \rightarrow \blacktriangledown Down \rightarrow \blacktriangledown Up (\rightarrow Center \blacktriangledown) * 4:3 small may not be displayed normally by an input signal.	✓	✓

OPERATIONS (continued)

Input Menu

The following functions are available when INPUT is selected on the menu. Select an item with the  and  buttons, and start or stop operation with the  and  buttons.

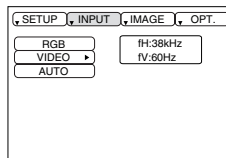

Table 1.4 Input Menu





Item	Description
RGB	<p>Displays RGB input frequency: Displays the horizontal and vertical sync signal frequency for RGB input.</p> <p>* It is effective only at the time of input of RGB.</p>
VIDEO	<p>Select video signal type: Select the signal type with the  and  buttons. Select NTSC, PAL SECAM, NTSC4.43, M-PAL, or N-PAL as appropriate for the input signal. Auto Adjust is valid at VIDEO/S-VIDEO input when AUTO is selected, and is then used for automatic selection of the signal type.</p> <p>* Use this function when the image becomes unstable (eg. the image becomes irregular, or lacks color).</p> <p>* Auto Adjust requires approximately ten seconds. It may not function correctly with some input signals. Pressing the AUTO! button in this case may correct this problem.</p>
AUTO	<p>Automatic adjustment at RGB input: Select EXECUET with the  button. Horizontal position, vertical position, clock phase, and horizontal size are automatically adjusted when RUN is selected. Use with the window at maximum size in the application display.</p> <p>Automatic adjustment at VIDEO/S-VIDEO input: Select EXECUET with the  button. A signal type appropriate for the input signal is selected automatically when EXECUET is selected. Valid only if AUTO is selected in VIDEO (see above).</p> <p>* This operation requires approximately ten seconds. It may not function correctly with some input signals. Pressing the AUTO button in this case may correct this problem.</p> <p>* This function is the same as for Auto Adjust in Basic operation.</p>

Image Menu

The following adjustments and settings are available when IMAGE is selected on the menu. Select an item with the ▲ and ▼ buttons, and start operation.

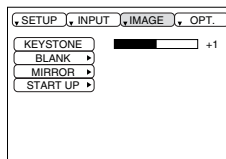

Table 1.5 Image Menu

Item	Description
KEYSTONE	Adjustment: Reduce size of bottom of image ◀ ↔ Reduce size of top of image ▶
BLANK	Select blank screen color: Select color with the ◀ and ▶ buttons. * The image is cleared when the BLANK MODE is set with BLANK ON, or when there is no signal, and the entire screen is displayed in the selected color. Note that if TURN OFF is selected on the START UP the blank screen is displayed in blue when there is no signal.
MIRROR	Operation start/stop: Press the ▶ or ◀ button. Select Mirror status: Select mirror status with ▲ and ▼ buttons.
START UP	Operation start/stop: Press the ▶ or ◀ button. Setup initial screen display: Select TURN ON with the ▲ button. Clear initial screen display: Select TURN OFF with the ▼ button. * Note that if TURN OFF is selected the blank screen is displayed in blue when there is no signal.

OPERATIONS (continued)

Options Menu

The following adjustments and settings are available when OPTIONS is selected on the menu. Select an item with the ▲ and ▼ buttons, and start operation.

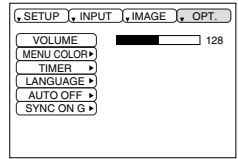

Table 1. 6 Options Menu

Item	Description
VOLUME	Volume adjustment: Reduce VOLUME ◀ ↔ Increase VOLUME ▶
MENU COLOR	Select menu background color: Select with the ▶ and ◀ buttons.
TIMER	Operation start/stop: Press the ▶ or ◀ button. Setup initial timer value: Set 1~99 minutes with the ▲ and ▼ buttons.
LANGUAGE	Operation start/stop: Press the ▶ or ◀ button. Select menu display language: Select with the ▲ and ▼ buttons.
AUTO OFF	Operation start/stop: Press the ▶ or ◀ button. Set AUTO OFF: Set 0~99 minutes with the ▲ and ▼ buttons. The system automatically enters the standby mode when a signal is not received for the set time. Clear AUTO OFF: Select STOP (0 min.) with the ▼ button. Wind Stop is selected the system does not enter the standby mode even if no signal is received.
SYNC ON G	Operation start/stop: Press the ▶ or ◀ button. SYNC ON G valid: Select TURN ON with the ▲ button. SYNC ON G invalid: Select TURN OFF with the ▼ button. * When SYNC ON G is effective, it may not be displayed normally by an input signal. Remove a signal connector, and make it condition without a signal, and input a signal again in this case SYNC ON G after it is overridden.

No Signal Menu

The same adjustments and settings are available as with the Image and Options menus when the MENU button is pressed during display of the 'NO INPUT IS DETECTED ON ***' or 'SYNC IS OUT OF RANGE ON ***' message while no signal is received. See Table 1.7 below.

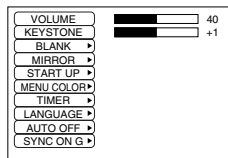

Table 1.7 No Signal Menu

Item	Description
VOLUME	Volume adjustment: Reduce VOLUME ◀ ↔ Increase VOLUME ▶
KEYSTONE	Adjustment: Reduce size of bottom of image ◀ ↔ Reduce size of top of image ▶
BLANK	Select blank screen color: Select color with the ◀ and ▶ buttons. * The image is cleared when the BLANK MODE is set with BLANK ON, or when there is no signal, and the entire screen is displayed in the selected color. Note that if TURN OFF is selected on the START UP the blank screen is displayed in blue when there is no signal.
MIRROR	Operation start/stop: Press the ▶ or ◀ button. Select Mirror status: Select mirror status with ▲ and ▼ buttons.
START UP	Operation start/stop: Press the ▶ or ◀ button. Setup initial screen display: Select TURN ON with the ▲ button. Clear initial screen display: Select TURN OFF with the ▼ button. * Note that if TURN OFF is selected the blank screen is displayed in blue when there is no signal.
MENU COLOR	Select menu background color: Select with the ▶ and ◀ buttons.
TIMER	Operation start/stop: Press the ▶ or ◀ button. Setup initial timer value: Set 1~99 minutes with the ▲ and ▼ buttons.
LANGUAGE	Operation start/stop: Press the ▶ or ◀ button. Select menu display language: Select with the ▲ and ▼ buttons.
AUTO OFF	Operation start/stop: Press the ▶ or ◀ button. Set AUTO OFF: Set 0~99 minutes with the ▲ and ▼ buttons. The system automatically enters the standby mode when a signal is not received for the set time. Clear AUTO OFF: Select STOP (0 min.) with the ▼ button. Wind Stop is selected the system does not enter the standby mode even if no signal is received.
SYNC ON G	Operation start/stop: Press the ▶ or ◀ button. SYNC ON G valid: Select TURN ON with the ▲ button. SYNC ON G invalid: Select TURN OFF with the ▼ button. * When SYNC ON G is effective, it may not be displayed normally by an input signal. Remove a signal connector, and make it condition without a signal, and input a signal again in this case SYNC ON G after it is overridden.

MAINTENANCE

Lamps



Electric shock
High temperature
Mechanical shock

Contact your dealer before replacing the lamp.

(Product name: Projector lamp /Model name: DT00301)

Before replacing the lamp, switch power OFF, remove the power cord from the power outlet, and wait approximately 45 minutes until the lamp has cooled. The lamp may explode if handled at high temperatures.

* For disposal of used lamp, treat according to the instruction of community authorities.

* Since the lamp is made of glass, do not apply shock to it and do not scratch it.

* Also, do not use old lamp. This could also cause explosion of the lamp.

* If it is probable that the lamp has exploded (explosive sound is heard), disconnect the power plug from the power outlet and ask your dealer to replace lamp.

The lamp is covered by front glass and air-tight structure, but, in rare cases, the reflector and the inside of the projector may be damaged by scattered broken pieces of glass, and broken pieces could cause injury when being handled.

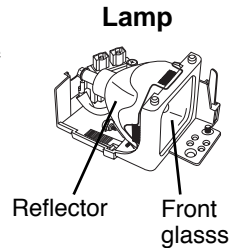

Lamp Life

Projector lamps have a finite life. The image will become darker, and hues will become weaker, after a lamp has been used for a long period of time.

Replace the lamp if the LAMP indicator is red, or the CHANGE THE LAMP message (see Table 1.8) appears when the projector is switched ON.



The LAMP is also red when the lamp unit reaches high temperature. Before replacing the lamp, switch power OFF, wait approximately 20 minutes, and switch power ON again. If the LAMP indicator is still red, replace the lamp.

Replacing the Lamp

1. Switch the projector OFF, remove the power cord from the power outlet, and wait at least 45 minutes for the unit to cool.
2. Prepare a new lamp.
3. Check that the projector has cooled sufficiently, and gently turn it upside down.
4. Remove the two screws as shown in the diagram, and remove the lamp cover.
5. Remove the one screw, and gently remove the lamp while holding the grips. Touching the inside of the lamp case may result in uneven coloring.
6. Install the new lamp and tighten the one screw firmly.
7. Replace the lamp cover in position and tighten the two screws firmly.
8. Gently turn the projector right-side up.

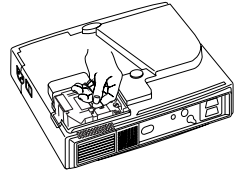
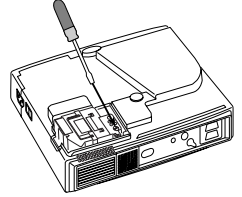
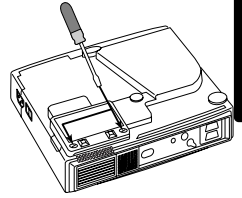

* Ensure that screws are tightened properly. Screws not tightened fully may result in injury or accidents.

* Do not use the projector with the lamp cover removed.

Resetting the Lamp Timer

Reset the lamp timer after replacing the lamp. When the lamp has been replaced after the LAMP indicator is red, or the CHANGE THE LAMP message is displayed, complete the following operation within ten minutes of switching power ON. The power will be turned off automatically in over 10 minutes.

1. Switch power ON, and press the TIMER button on the remote controller, or the RESET button on the control panel, for approximately three seconds. The 'LAMP xxxx hr' message will appear on the lamp timer on the bottom of the screen.
2. Press the MENU button on the remote controller, or the RESET button on the control panel, while the lamp timer is displayed. The 'LAMP xxxx □ → 0 ■ CANCEL' message will then appear.
3. Press the  and select 0, and wait until the timer display is cleared.



The message functions will not operate properly if the lamp timer is reset without replacing the lamp, or the lamp timer is not reset when the lamp is replaced.

Air Filter Maintenance



Switch power OFF and remove the power cord from the power outlet, before beginning maintenance work.

The air filter should be cleaned as described below at intervals of approximately 100 hours.

1. Switch the projector power supply OFF, and remove the power cord from the power outlet.
2. Remove the air filter as shown in the diagram.
3. Vacuum the air filter.
4. Replace the air filter with the reverse procedure.

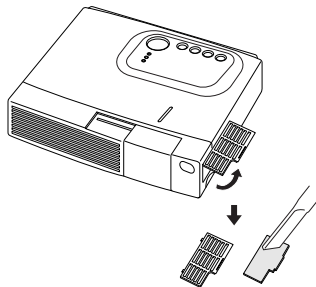

- * Replace the air filter if contamination cannot be removed, or if it is damaged. Contact your dealer in such case.(Product name: Air filter : MU01291)
- * Do not use the equipment with the air filter removed.
- * When the air filter is clogged with dust etc. the CHECK AIR FLOW message appears on the screen and the power supply is switched OFF automatically to prevent the temperature rising inside the projector.

Other Maintenance



Switch power OFF and remove the power cord from the power outlet, before beginning maintenance work.

Inside maintenance

Ask a store for cleaning, the check toward an approximate goal of one time in 2 for the safe use. Stop care by yourself absolutely because it is dangerous.

The maintenance of the lens

Wipe it lightly by the lens cleaning paper on the market. Don't touch a lens.

Maintenance of the Cabinet and Remote controller

Wipe it lightly with the cloth whose thing in such cases as the gauze is soft. Soak soft cloth in the synthetic detergent thinned with the water or the water and wipe an iris well lightly when dirt is cruel. Furthermore, wipe it lightly with the soft cloth which dried, and finish it.



- * The benzine and the paint thinner aren't to use a detergent except for the above and medicine.
- * Don't use spray.
- * Don't scratch it with the stiff thing and don't strike it.

TROUBLESHOOTING

OSD Message

A message like the bottom table sometimes displays it with this opportunity at the time of power source on.

Cope in accordance with the bottom table if message appears on the screen.

Table 1-8. Message display list.

Message	Contents
CANGE THE LAMP AFTER REPLACING LAMP, RESET THE LAMP TIME. *1)	Left message is displayed when ramp use time is 1700 hours. The use time of the ramp draws near in the life. A power source is turned off automatically when the use time of the ramp reaches a life. Recommend the setup of the new ramp and a little early switching. Be sure to reset a ramp timer after the ramp switching.
CANGE THE LAMP AFTER REPLACING LAMP, RESET THE LAMP TIME. THE POWER WILL TURN OFF AFTER ** hr. *1)	Left message is displayed when ramp use time passes 1779 hours. It is more ** time until the use time of the ramp reaches a life. When ** time is more used, a power source is turned off automatically. Exchange a ramp in accordance with 1-17-page "ReplacingtheLamp". Be sure to reset a ramp timer after the ramp resetting.
CANGE THE LAMP AFTER REPLACING LAMP, RESET THE LAMP TIME. THE POWER WILL TURN OFF AFTER 0 hr.	A power source will be turned off automatically soon because the use time of the ramp reached a life. Turn off a power source soon and exchange a ramp in accordance with 1-17-page "ReplacingtheLamp". Be sure to exchange a ramp and reset a ramp timer after the switching.
NO INPUT IS DETECTED ON ***	There is no signal input Verification is to give me the condition of the connection of input of a signal and the signal source.
SYNC IS OUT OF RANGE ON ***	The current horizontal or vertical frequency cannot be used by this projector Verification is to give me the specification of this opportunity and the signal source.
CHECK THE AIR FLOW	Internal overheating. Wait approximately 20 min. and then turn the power on again. * Make sure the ventilation openings are not blocked. * Clean the air filter. * Lower the ambient temperature to 35 degrees C or less.



*1) This display will disappear after 3min. but will reappear when the power is turned on again.

TROUBLESHOOTING (continued)

Indicators Message

The POWER indicator, LAMP indicator and TEMP indicator light or blink in the following cases.

Table 1-9. Indicators Message list

POWER indicator	LAMP indicator	TEMP indicator	Contents
Lights orange	Turns off	Turns off	Standby status
Blinks green	Turns off	Turns off	Warming up. Wait.
Lights green	Turns off	Turns off	Operation status.
Blinks orange	Turns off	Turns off	Cool down.
Lights red	Lights red	Turns off	The lamp does not light. Wait some time (approx. 20 min.) before turning the power on again. If the indicator still lights, the lamp may have failed and. Replace with a new lamp.
Lights red	Blinks red	Turns off	A lamp has not been inserted or the lamp cover is missing. Cut a power source, and happen for about 45 minutes, and confirm the condition which a ramp and a ramp cover mount this opportunity after cooling it fully. Make contact with the store when a power source is made ON again after the modification and it becomes the same display again.
Lights red	Turns off	Blinks red	The cooling fan is not operating. Cut a power source, and happen for about 20 minutes, and confirm this opportunity after cooling it whether a foreign substance isn't caught in the fan. Make contact with the store when a power source is made ON again after the modification and it becomes the same display again.
Lights red	Turns off	Lights red	Internal overheating. *1) Confirm this opportunity with the air filter if you don't become dirty or ambient air temperature doesn't exceed 35 degrees if intake mouth and an exhaust mouth aren't occupied after cooling it cut a power source it happens for about 20 minutes. Make contact with the store when a power source is made ON again after the modification and it becomes the same display again.





*1) In some cases, when the air holes becomes blocked and the interior temperature rises, the lamp will be turned off for protection and the LAMP indicator will flash red. In such cases, turn off the MAIN POWER switch, allow the set to cool (for approx. 20 min.) and then turn the power on again.

Symptom

Before requesting repair, check in accordance with the following chart. If the situation cannot be corrected, then contact your dealer.

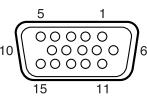

Table 1-10. Symptom

Symptom	Possible cause	Remedy	Page
The power is not turned on.	<ul style="list-style-type: none"> * main power switch is not turned on. * The power cord is disconnected. 	<ul style="list-style-type: none"> * Turn on the main power switch. * Plug the power cord into an AC power outlet. 	
No video or audio.	<ul style="list-style-type: none"> * The input is not correctly set. * No signal input. 	<ul style="list-style-type: none"> * Use the projector or remote control to set. * Connect correctly. 	
Video is present but no audio.	<ul style="list-style-type: none"> * The projector is not correctly connected. * The volume is set to minimum. * Mute is turned on. 	<ul style="list-style-type: none"> * Connect correctly. * Press VOLUME  on the remote control or display the menu screen and adjust the volume. * Press the MUTE button. 	
Audio is present but no video.	<ul style="list-style-type: none"> * The projector is not correctly connected. * The brightness adjustment knob is rotated fully clockwise. * The slide lens door is still closed. 	<ul style="list-style-type: none"> * Connect correctly. * Select BRIGHT with the MENU button and the press the  button. * Open the slide lens door. 	
Colors are pale and color matching is poor.	Color density and color matching are not correctly adjusted.	Adjust the video.	
Images are dark.	<ul style="list-style-type: none"> * Brightness and contrast are not correctly adjusted. * The lamp is nearing the end of its service life. 	<ul style="list-style-type: none"> * Adjust the video. * Replace with a new lamp. 	
Video is blurred.	Focus or H PHASE is out of adjustment.	Adjust the focus or H PHASE.	
The LAMP indicator lights red.	Lamp failure.	Wait approximately 20 min. and then turn the power on again.	
The TEMP indicator lights red.	Internal overheating.	<ul style="list-style-type: none"> * Make sure the ventilation openings are not blocked. * Clean the air filter. * Lower the ambient temperature to 35 degrees C or less. 	
The LAMP indicator blinks red.	<ul style="list-style-type: none"> * The lamp cover is not set correctly. * The lamp is not set correctly. 	* Check and correct the setting of lamp cover and lamp.	

SPECIFICATIONS

NOTE : These specifications are subject to change without notice.

Table 1-11. Specifications

Item		Specification																								
Product name		Liquid crystal projector																								
Model		CP-S220W																								
Liquid crystal panel	Panel size	1.8 cm (0.7 type)																								
	Drive system	TFT active matrix																								
	Pixels	485,616 pixels (604 horizontal x 804 vertical)																								
Lens		Zoom lens F=2.0 ~ 2.3 f=18 ~ 21 mm																								
Lamp		130 W UHB																								
Speaker		0.7 W																								
Power supply		AC100 ~ 120V, 2.0A / AC220 ~ 240V, 0.9A																								
Power consumption		200 W																								
Temperature range		0 ~ 35°C (Operating)																								
Size		289 (W) x 70 (H) x 210 (D) mm																								
Weight (mass)		2.38 kg or less																								
INPUT signal	RGB	Video: Analog 0.7Vp-p, 75Ω terminator (positive) H/V. sync.: TTL level (positive/negative) Compound sync.: TTL level D-sub 15-pin shrink jack																								
																										
		<table border="1"> <tr> <td>7</td> <td>Ground Green</td> </tr> <tr> <td>8</td> <td>Ground Blue</td> </tr> <tr> <td>9</td> <td>-</td> </tr> </table>	7	Ground Green	8	Ground Blue	9	-																		
		7	Ground Green																							
		8	Ground Blue																							
		9	-																							
		<table border="1"> <tr> <td>1</td> <td>Video input Red</td> <td>10</td> <td>Ground</td> </tr> <tr> <td>2</td> <td>Video input Green</td> <td>11</td> <td>-</td> </tr> <tr> <td>3</td> <td>Video input Blue</td> <td>12</td> <td>DDC jack</td> </tr> <tr> <td>4</td> <td>-</td> <td>13</td> <td>H. sync./ Compound sync.</td> </tr> <tr> <td>5</td> <td>Ground (DDC)</td> <td>14</td> <td>Vertical sync</td> </tr> <tr> <td>6</td> <td>Ground Red</td> <td>15</td> <td>DDC jack</td> </tr> </table>	1	Video input Red	10	Ground	2	Video input Green	11	-	3	Video input Blue	12	DDC jack	4	-	13	H. sync./ Compound sync.	5	Ground (DDC)	14	Vertical sync	6	Ground Red	15	DDC jack
		1	Video input Red	10	Ground																					
		2	Video input Green	11	-																					
		3	Video input Blue	12	DDC jack																					
		4	-	13	H. sync./ Compound sync.																					
		5	Ground (DDC)	14	Vertical sync																					
		6	Ground Red	15	DDC jack																					
		VIDEO		1.0Vp-p, 75Ω terminator, RCA jack																						
		S-VIDEO		Brightness signal: 1.0Vp-p, 75Ω terminator Color signal: 0.286Vp-p (burst signal), 75Ω terminator Mini DIN 4-pin jack																						
																										
AUDIO		200mVrms, 47 kΩ or less (max. 3.0Vp-p) Stereo mini jack (Speaker output is L/R mixed.)																								
CONTROL signal		D-sub 15-pin shrink jack																								

SPECIFICATIONS (continued)

Dimension Diagram

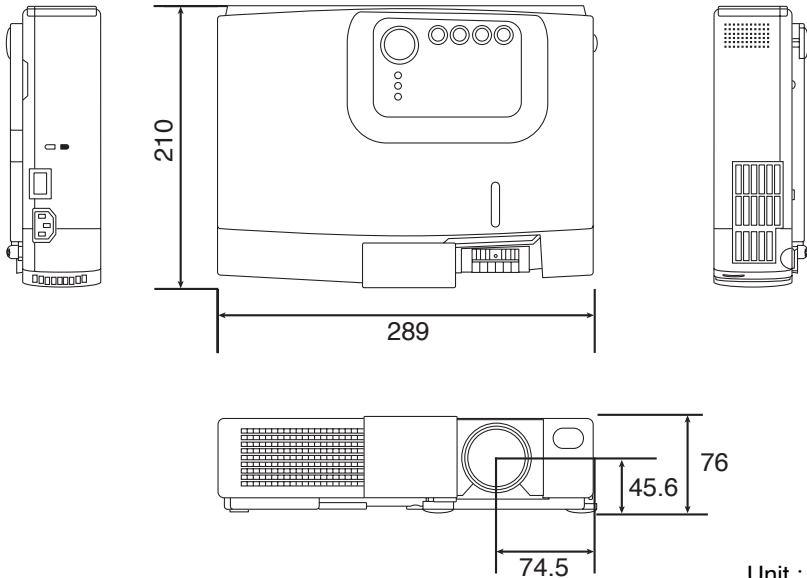

Unit : mm

ENGLISH

WARRANTY AND AFTER-SERVICE



A warranty is provided for this product. Fill in the necessary items and store in a safe place.

- * When a problem occurs, please check first using the Troubleshooting Chart provided in this instruction manual. If the problem still persists, contact your dealer or service company.
- * Repairs will be made as described in the warranty. For details, please read the warranty.
- * Paid repairs will be made if desired in the event that the function can be restored by such repairs.

REGULATORY NOTICES

FCC Statement Warning

WARNING: This equipment has been tested and found to comply with the limits for a Class B digital device, pursuant to Part 15 of the FCC Rules. These limits are designed to provide reasonable protection against harmful interference in a residential installation. This equipment generates, uses, and can radiate radio frequency energy and, if not installed and used in accordance with the instructions, may cause harmful interference to radio communications. However, there is no guarantee that interference will not occur in a particular installation. If this equipment does cause harmful interference to radio or television reception, which can be determined by turning the equipment off and on, the user is encouraged to try to correct the interference by one or more of the following measures:

- Reorient or relocate the receiving antenna.
- Increase the separation between the equipment and receiver.
- Connect the equipment into an outlet on a circuit different from that to which the receiver is connected.
- Consult the dealer or an experienced radio/TV technician for help.

INSTRUCTIONS TO USERS: This equipment complies with the requirements of FCC (Federal Communication Commission) equipments provided that following conditions are met.

(1) Power cord:

(2) Video inputs:

CAUTION: Changes or modifications not expressly approved by the party responsible for compliance could void the user's authority to operate the equipment.

For the Customers in CANADA

NOTICE: This Class B digital apparatus complies with Canadian ICES-003.

Example of computer signal

Resolution H × V	fH (kHz)	fV (Hz)	Rating	Signal mode	Display mode	Note 1
640 × 350	37.9	85.1	VESA	VGA-1	Zoom in	
640 × 400	37.9	85.1	VESA	VGA-2	Zoom in	
720 × 400	37.9	85.0	VESA	TEXT	Zoom in	
640 × 480	31.5	59.9	VESA	VGA-3	Zoom in	
640 × 480	35.0	66.7		Mac13"mode	Zoom in	SW 1 ON SW 2 ON
640 × 480	37.9	72.8	VESA	VGA-3(72Hz)	Zoom in	
640 × 480	37.5	75.0	VESA	VGA-3(75Hz)	Zoom in	
640 × 480	43.3	85.0	VESA	VGA-3(85Hz)	Zoom in	
800 × 600	35.2	56.3	VESA	SVGA(56Hz)		
800 × 600	37.9	60.3	VESA	SVGA(60Hz)		
800 × 600	48.1	72.2	VESA	SVGA(72Hz)		
800 × 600	46.9	75.0	VESA	SVGA(75Hz)		
800 × 600	53.7	85.1	VESA	SVGA(85Hz)		
832 × 624	49.7	74.5		Mac16"mode	Zoom out	SW 2 ON SW 4 ON
1024 × 768	48.4	60.0	VESA	XGA(60Hz)	Zoom out	
1024 × 768	56.5	70.1	VESA	XGA(70Hz)	Zoom out	
1024 × 768	60.0	75.0	VESA	XGA(75Hz)	Zoom out	

Note 1: Mac adapter is necessary to the resolution mode.
 Projector is compatible with 13 inch mode and 16 inch mode.
 Mac 13" mode=switch 1 and switch 2 are ON.
 Mac 16" mode=switch 2 and switch 4 are ON.

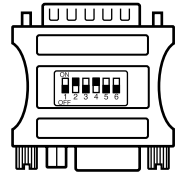

(Example 16 inch mode)

- Caution**
- Some computers may have multiple display screen modes. Use of some of these modes will not be possible with this projector.
 - Be sure to check jack type, signal level, timing and resolution before connecting this projector to a computer.
 - Depending on the input signal, full-size display may not be possible in some cases. Refer to the number of display pixels above.

Initial set signals

The following signals are used for the initial settings.

The signal timing of some computer models may be different. In such case, refer to pages 17 and 18 and adjust the V.POSIT and H.POSIT of the menu.

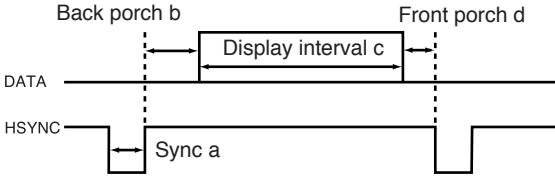

Computer / Signal	Horizontal signal timing (μ s)			
	a	b	c	d
VGA-1(85Hz)	2.0	3.0	20.3	1.0
VGA-2(85Hz)	2.0	3.0	20.3	1.0
TEXT	2.0	3.0	20.3	1.0
VGA-3	3.8	1.9	25.4	0.6
Mac 13"mode	2.1	3.2	21.2	2.1
VGA-3(72Hz)	1.3	3.8	20.3	1.0
VGA-3(75Hz)	2.0	3.8	20.3	0.5
VGA-3(85Hz)	1.6	2.2	17.8	1.6

Computer / Signal	Horizontal signal timing (μ s)			
	a	b	c	d
SVGA(56Hz)	2.0	3.6	22.2	0.7
SVGA(60Hz)	3.2	2.2	20.0	1.0
SVGA (72Hz)	2.4	1.3	16.0	1.1
SVGA (75Hz)	1.6	3.2	16.2	0.3
SVGA (85Hz)	1.1	2.7	14.2	0.6
Mac 16"mode	1.1	3.9	14.5	0.6
XGA (60Hz)	2.1	2.5	15.8	0.4
XGA (70Hz)	1.8	1.9	13.7	0.3
XGA (75Hz)	1.2	2.2	13.0	0.2

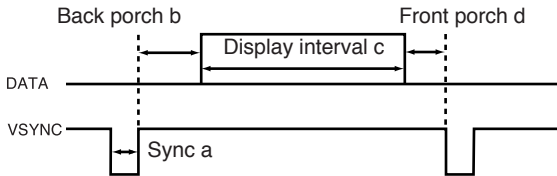

Computer / Signal	Vertical signal timing (lines)			
	a	b	c	d
VGA-1(85Hz)	3	60	350	32
VGA-2(85Hz)	3	41	400	1
TEXT	3	42	480	1
VGA-3	2	33	480	10
Mac 13"mode	3	39	480	3
VGA-3(72Hz)	3	28	480	9
VGA-3(75Hz)	3	16	480	1
VGA-3(85Hz)	3	25	480	1

Computer / Signal	Vertical signal timing (lines)			
	a	b	c	d
SVGA(56Hz)	2	22	600	1
SVGA(60Hz)	4	23	600	1
SVGA (72Hz)	6	23	600	37
SVGA (75Hz)	3	21	600	1
SVGA (85Hz)	3	27	600	1
Mac 16"mode	3	39	624	1
XGA (60Hz)	6	29	768	3
XGA (70Hz)	6	29	768	3
XGA (75Hz)	3	28	768	1